

The Drawn Thread

SPRING SCISSORS KEEPER

Supplies: 36 to 40 count White or Off White Linen and floss as listed in color key at right.

Directions: Find the center of your fabric and start your scissors keep there. Follow the color key at right for stitches & colors.

Finishing: Count out 22 threads from each point of design area. Score and then cut away excess fabric. Fold the keep in half horizontally (right sides together) and stitch across each side 8 threads in from the cut edge. Turn right side out. Fold under eight threads along unfinished edge (toward inside). Make twisted cord from DMC Ecu or White. Fold in half and knot at ends. Insert knotted end into opening of keep and begin to whip stitch opening together. Leave a small area unstitched at the bottom. Fill with rice. After filling, finish whip stitching the opening together. Loop cord through scissors.

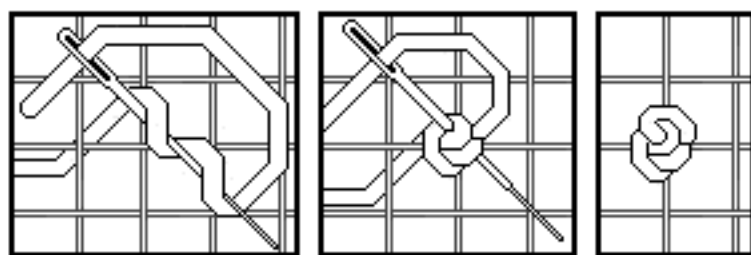
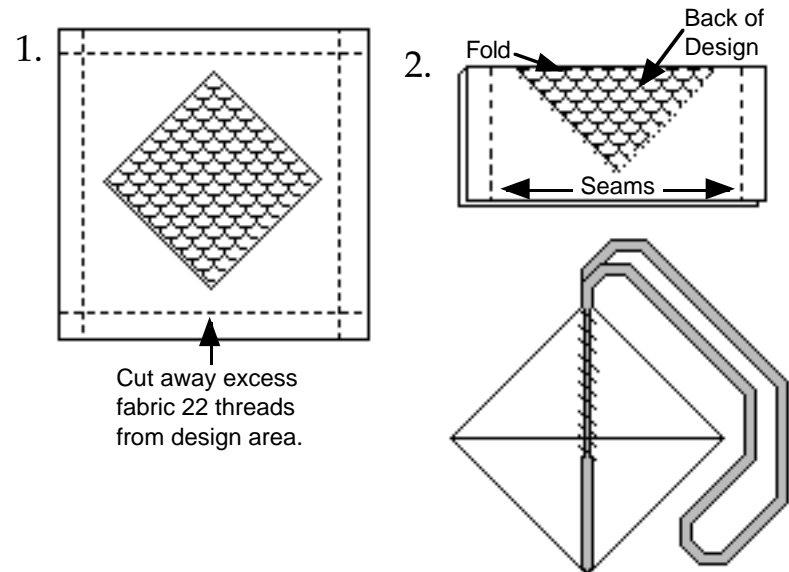
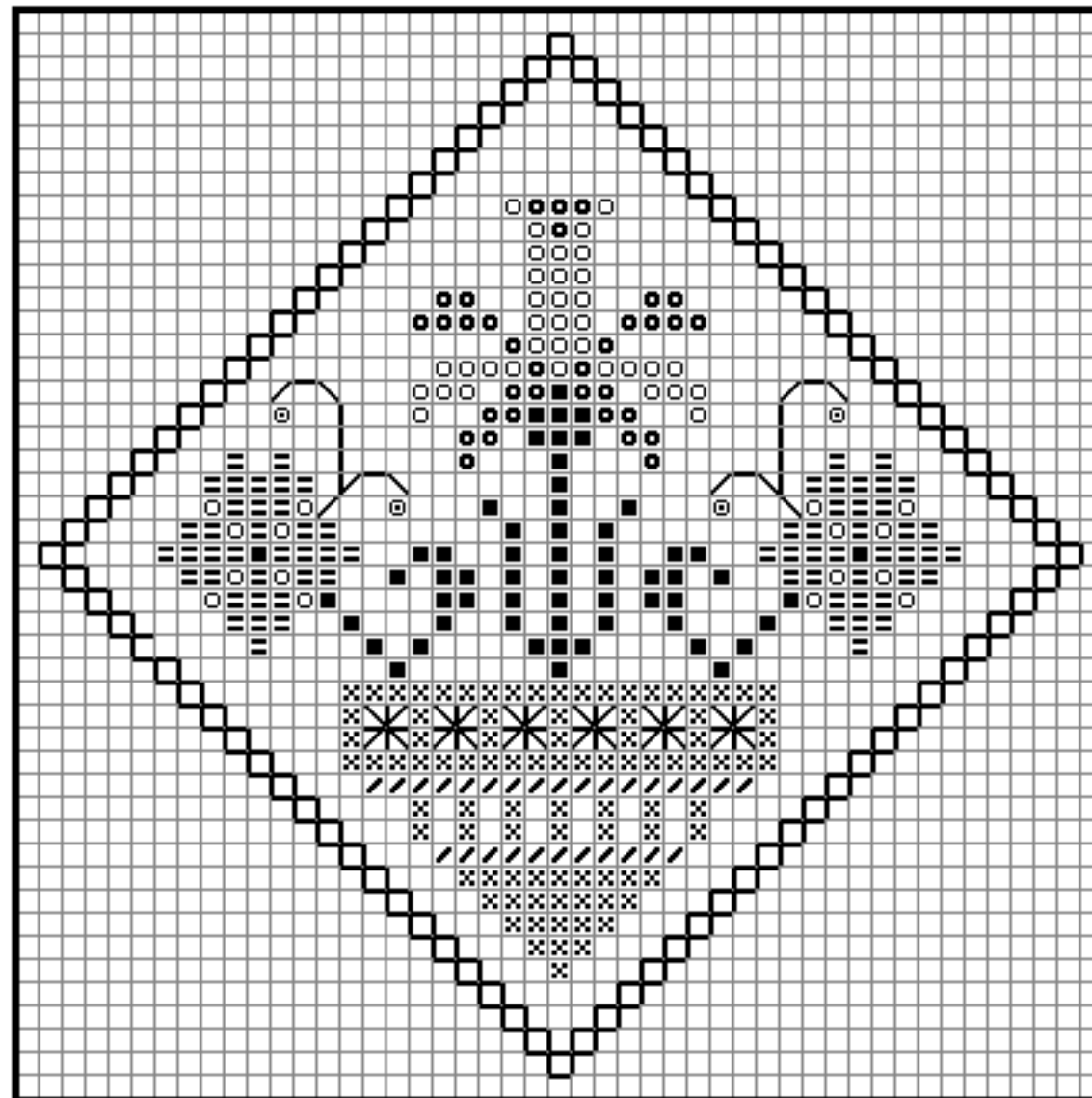

French Knot

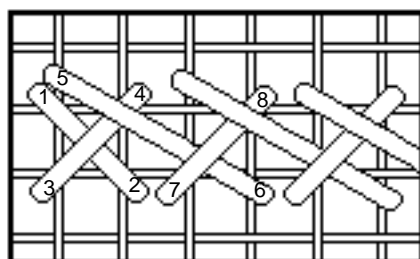

Williamsburg Stitch - Step 1

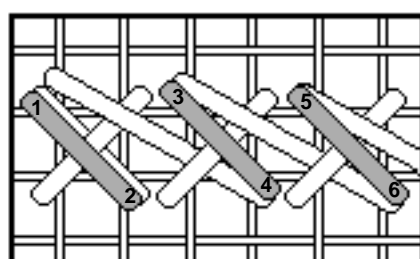

Williamsburg Stitch - Step 2

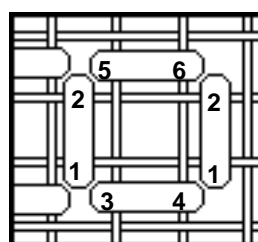

Four Sided Stitch

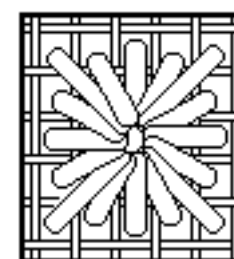

Eyelet Stitch

- ◻ Needlepoint Silk 694 Honeysuckle Medium or DMC 729
- ◻ Needlepoint Silk 471, Autumn Yellow or DMC 676
- Needlepoint Silk 292, Jacobean Green or DMC 3051
- ▬ Silk N'Colors Grape Melange or Needle Necessities Overdyed Floss 194, Mauvelous, or substitute DMC 3041
- ⊗ Needlepoint Silk 761 Biscuit Brown or DMC 3782
- ↗ Williamsburg Stitch Step 1 in Biscuit Brown, Step 2 in Grape Melange or DMC 3782 and your overdye substitute
- ⊠ French Knot in Grape Melange or your overdye substitute
- ⊗ Eyelet Stitch in Biscuit Brown or DMC 3782
- ◻ Four Sided stitch in Grape Melange or your overdye substitute
- ▬ Back stitch in Jacobean Green or DMC 3051